

## IGBT Discrete

$V_{CE}$	<b>650</b>	<b>V</b>
$I_C$	<b>60</b>	<b>A</b>
$V_{CE(SAT)} I_C=60A$	<b>2.10</b>	<b>V</b>

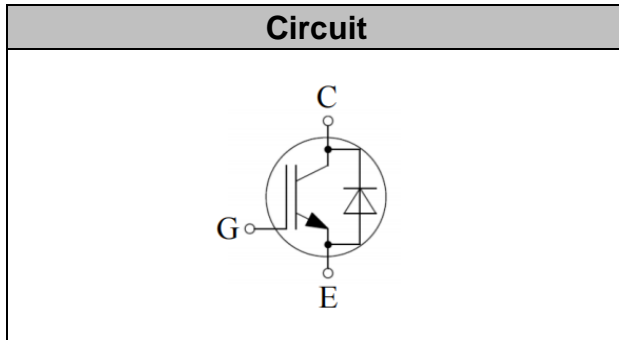

### Applications

- High frequency switching application
- Medical applications
- Uninterruptible power supply
- Motion/servo control

### Features

- Low switching losses
- Maximum junction temperature 175°C
- Positive temperature coefficient
- High ruggedness, temperature stable
- High short circuit capability(5us)

## Maximum Ratings

Parameter	Symbol	Value	Unit
Collector-Emitter Breakdown Voltage	$V_{CE}$	650	V
DC Collector Current, limited by $T_{jmax}$ $T_C=25^\circ C$ $T_C=100^\circ C$	$I_C$	120 60	A
Diode Forward Current, limited by $T_{jmax}$ $T_C=25^\circ C$ $T_C=100^\circ C$	$I_F$	60 30	A
Continuous Gate-Emitter Voltage	$V_{GE}$	$\pm 20$	V
Transient Gate-Emitter Voltage	$V_{GE}$	$\pm 30$	V
Turn off Safe Operating Area $V_{CE} \leq 1200V$ , $T_j \leq 150^\circ C$		240	A
Pulsed Collector Current, $V_{GE}=15V$ , $t_p$ limited by $T_{jmax}$	$I_{CM}$	240	A
Diode Pulsed Current, $t_p$ limited by $T_{jmax}$	$I_{Fpuls}$	120	A
Short Circuit Withstand Time, $V_{GE}=15V$ , $V_{CC}=400V$ , $V_{CEM} \leq 650V$	$T_{sc}$	5	$\mu s$
Power Dissipation, $T_j=175^\circ C$ , $T_C=25^\circ C$	$P_{tot}$	333	W



Operating Junction Temperature	$T_j$	-40...+175	°C
Storage Temperature	$T_s$	-55...+150	°C
Soldering Temperature, wave soldering 1.6mm (0.063in.) from case for 10s		260	°C

**Electrical Characteristics of the IGBT** ( $T_j=25^\circ\text{C}$  unless otherwise specified):

Parameter	Symbol	Conditions	Min.	Typ.	Max.	Unit
<b>Static</b>						
Collector-Emitter Breakdown Voltage	$BV_{CES}$	$V_{GE}=0V, I_C=250\mu A$	650		-	V
Gate Threshold Voltage	$V_{GE(th)}$	$V_{GE}=V_{CE}, I_C=0.8mA$	4.1	5.1	6.1	V
Collector-Emitter Saturation Voltage	$V_{CE(sat)}$	$V_{GE}=15V, I_C=60A$ $T_j=25^\circ\text{C}$ , $T_j=125^\circ\text{C}$ $T_j=150^\circ\text{C}$		2.10 2.40 2.50	2.40	V
Zero Gate Voltage Collector Current	$I_{CES}$	$V_{CE}=650V, V_{GE}=0V$ $T_j=25^\circ\text{C}$ , $T_j=150^\circ\text{C}$			0.25 4.00	mA
Gate-Emitter Leakage Current	$I_{GES}$	$V_{CE}=0V, V_{GE}=\pm 20V$			100	nA

Parameter	Symbol	Conditions	Min.	Typ.	Max.	Unit
<b>Dynamic</b>						
Input Capacitance	$C_{ies}$	$V_{CE}=25V, V_{GE}=0V,$ $f=1MHz$	-	2.04	-	nF
Reverse Transfer Capacitance	$C_{res}$		-	0.84	-	
Gate Charge	$Q_G$	$V_{CC}=300V, I_C=60A,$ $V_{GE}=15V$	-	0.24	-	uC
Short Circuit Collector Current	$I_{SC}$	$V_{GE}=15V, t_{sc}\leq 5\mu s,$ $V_{CC}=400V, T_j\leq 150^\circ\text{C}$	-	280	-	A

**Electrical Characteristics of the Diode** ( $T_j = 25^\circ\text{C}$  unless otherwise specified):

Parameter	Symbol	Conditions	Min.	Typ.	Max.	Unit
<b>Static</b>						
Diode Forward Voltage	$V_F$	$I_F = 30\text{A}$ $T_j = 25^\circ\text{C}$ , $T_j = 125^\circ\text{C}$ $T_j = 150^\circ\text{C}$		1.90 1.85 1.75	2.60	V

**Switching Characteristic, Inductive Load**

Parameter	Symbol	Conditions	Min.	Typ.	Max.	Unit
<b>Dynamic , at <math>T_j = 25^\circ\text{C}</math></b>						
Turn-on Delay Time	$t_{d(on)}$	$V_{CC} = 400\text{V}$ , $I_C = 60\text{A}$ , $V_{GE} = 0\text{V} \sim 15\text{V}$ , $R_g = 10\Omega$ , $L_s = 60\text{nH}$	-	18	-	ns
Rise Time	$t_r$		-	75	-	ns
Turn-on Energy	$E_{on}$		-	2.84	-	mJ
Turn-off Delay Time	$t_{d(off)}$		-	163	-	ns
Fall Time	$t_f$		-	62	-	ns
Turn-off Energy	$E_{off}$		-	1.21	-	mJ
<b>Dynamic , at <math>T_j = 125^\circ\text{C}</math></b>						
Turn-on Delay Time	$t_{d(on)}$	$V_{CC} = 400\text{V}$ , $I_C = 60\text{A}$ , $V_{GE} = 0\text{V} \sim 15\text{V}$ , $R_g = 10\Omega$ , $L_s = 60\text{nH}$	-	17	-	ns
Rise Time	$t_r$		-	65	-	ns
Turn-on Energy	$E_{on}$		-	2.86	-	mJ
Turn-off Delay Time	$t_{d(off)}$		-	176	-	ns
Fall Time	$t_f$		-	70	-	ns
Turn-off Energy	$E_{off}$		-	1.41	-	mJ
<b>Dynamic , at <math>T_j = 150^\circ\text{C}</math></b>						
Turn-on Delay Time	$t_{d(on)}$	$V_{CC} = 400\text{V}$ , $I_C = 60\text{A}$ , $V_{GE} = 0\text{V} \sim 15\text{V}$ , $R_g = 10\Omega$ , $L_s = 60\text{nH}$	-	16	-	ns
Rise Time	$t_r$		-	59	-	ns
Turn-on Energy	$E_{on}$		-	2.98	-	mJ
Turn-off Delay Time	$t_{d(off)}$		-	182	-	ns
Fall Time	$t_f$		-	82	-	ns
Turn-off Energy	$E_{off}$		-	1.51	-	mJ



## Electrical Characteristics of the DIODE

Parameter	Symbol	Conditions	Min.	Typ.	Max.	Unit
<b>Dynamic , at T<sub>j</sub>= 25°C</b>						
Reverse Recovery Current	I <sub>rr</sub>	I <sub>F</sub> =30A, V <sub>R</sub> =400V di/dt= -350A/μs,	-	7	-	A
Reverse Recovery Charge	Q <sub>rr</sub>		-	0.14	-	uC
Diode reverse recovery time	t <sub>rr</sub>		-	42	-	ns
Reverse Recovery Energy	E <sub>rec</sub>		-	0.09	-	mJ
<b>Dynamic , at T<sub>j</sub>= 125°C</b>						
Reverse Recovery Current	I <sub>rr</sub>	I <sub>F</sub> =30A, V <sub>R</sub> =400V di/dt= -350A/μs,	-	13	-	A
Reverse Recovery Charge	Q <sub>rr</sub>		-	0.94	-	uC
Diode reverse recovery time	t <sub>rr</sub>		-	153	-	ns
Reverse Recovery Energy	E <sub>rec</sub>		-	0.22	-	mJ
<b>Dynamic , at T<sub>j</sub>= 150°C</b>						
Reverse Recovery Current	I <sub>rr</sub>	I <sub>F</sub> =30A, V <sub>R</sub> =400V di/dt= -350A/μs,	-	15	-	A
Reverse Recovery Charge	Q <sub>rr</sub>		-	1.26	-	uC
Diode reverse recovery time	t <sub>rr</sub>		-	161	-	ns
Reverse Recovery Energy	E <sub>rec</sub>		-	0.26	-	mJ

## Thermal Resistance

Parameter	Symbol	Max. Value	Unit
IGBT Thermal Resistance, Junction - Case	R <sub>th(j-c)</sub>	0.45	K/W
Diode Thermal Resistance, Junction - Case	R <sub>th(j-c)</sub>	1.05	K/W
Thermal Resistance, Junction - Ambient	R <sub>th(j-a)</sub>	40	K/W

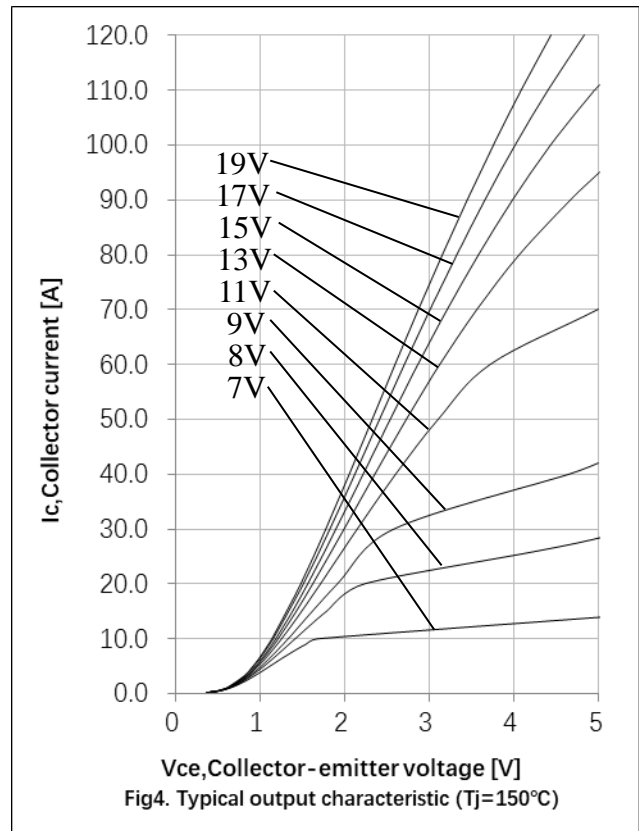
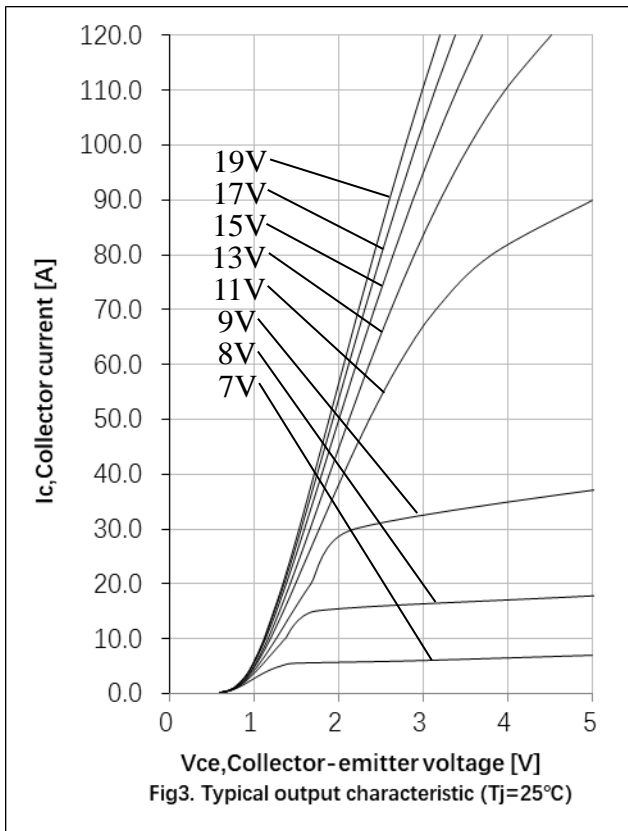
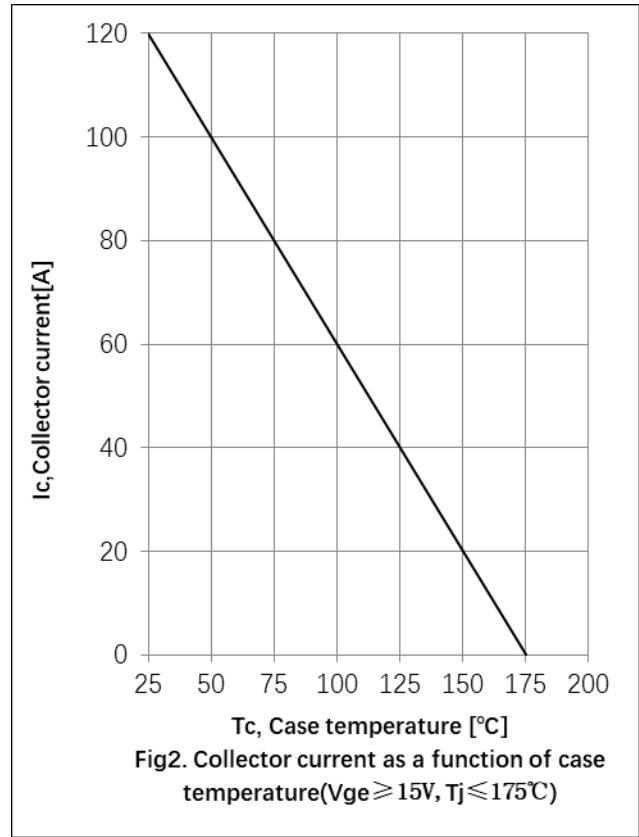
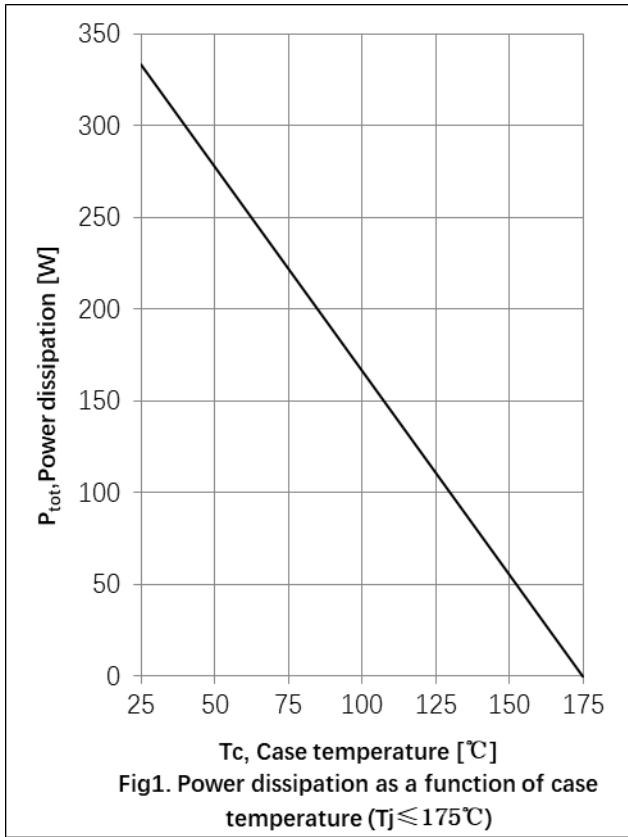

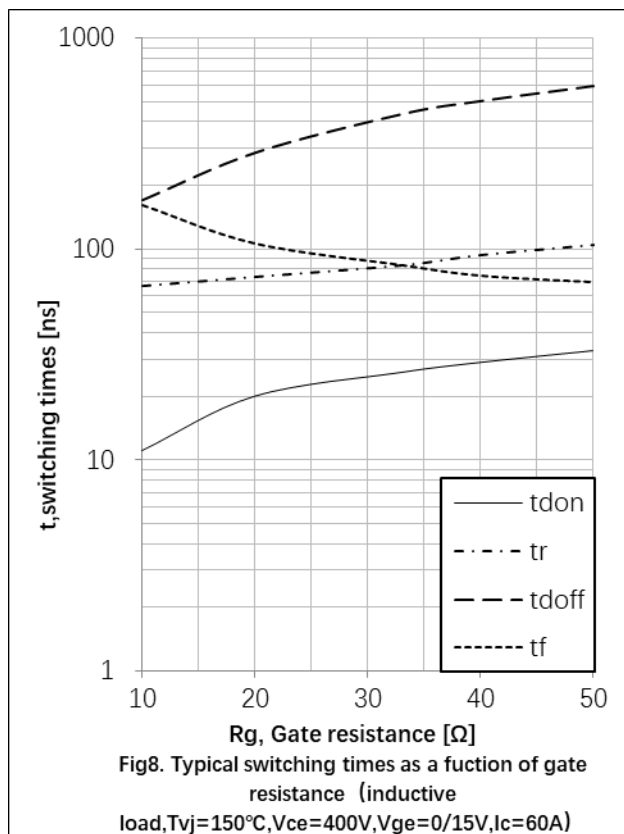
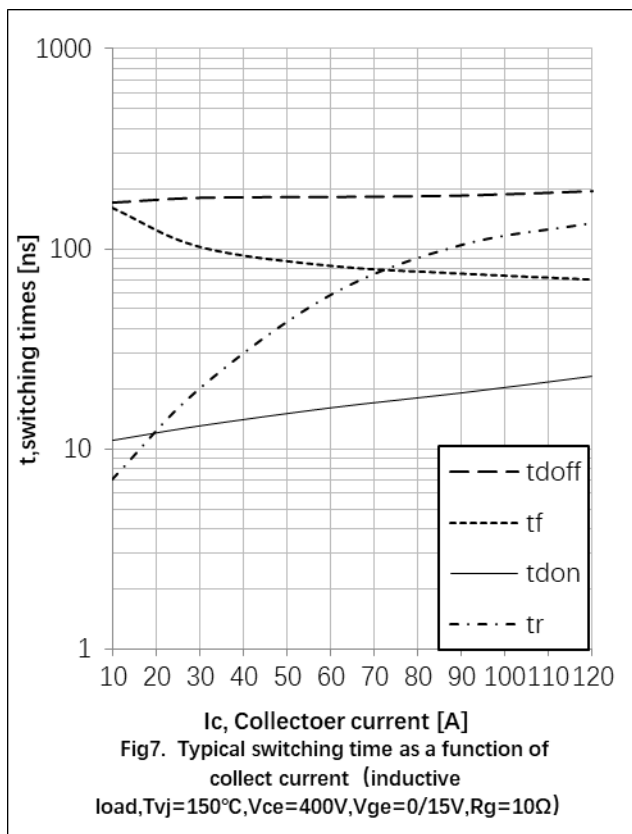
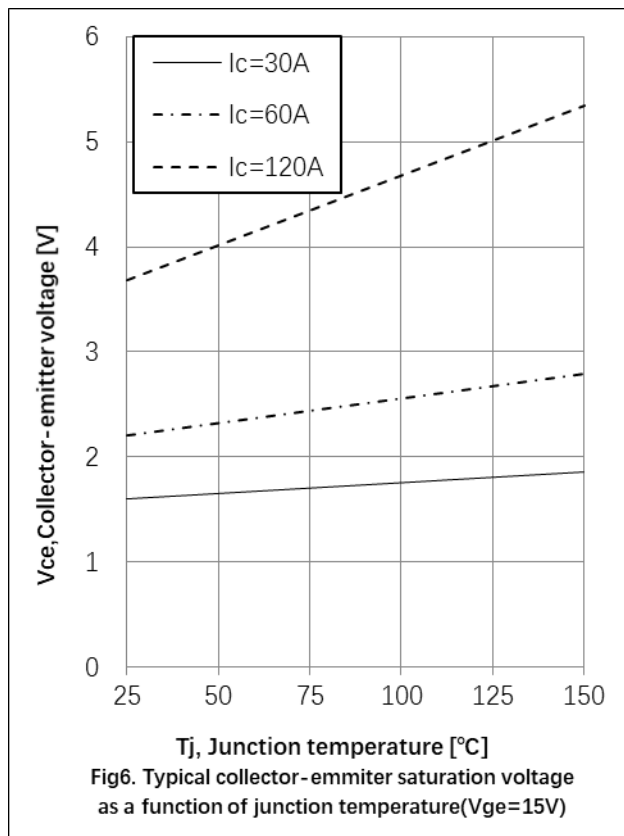
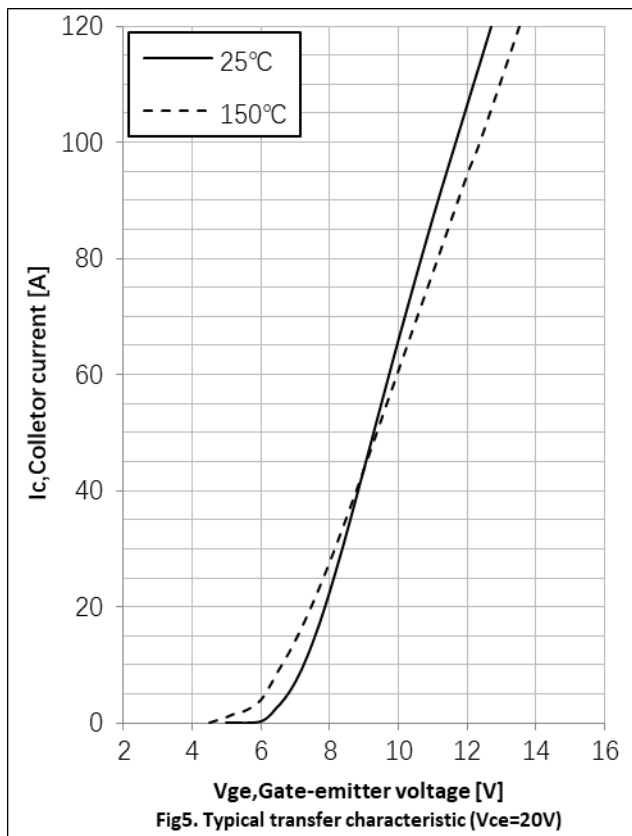

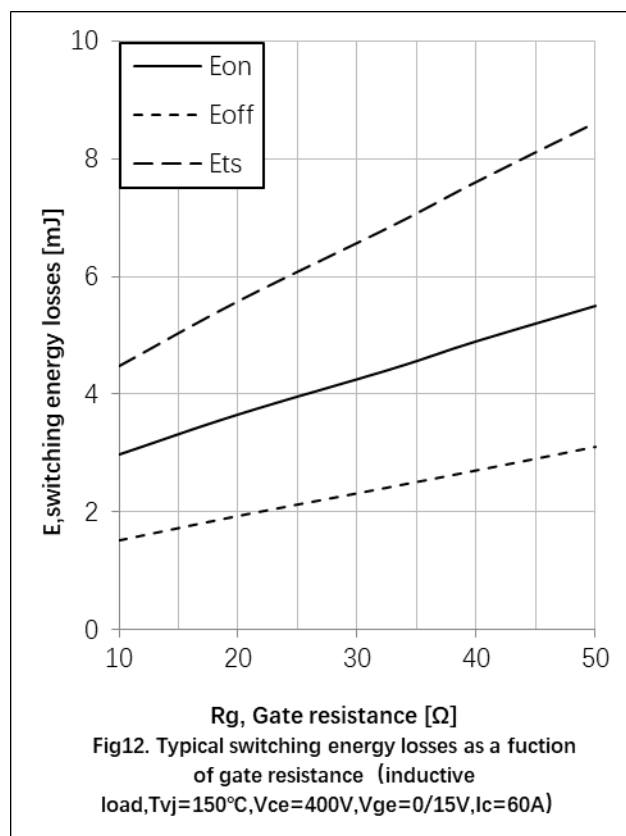
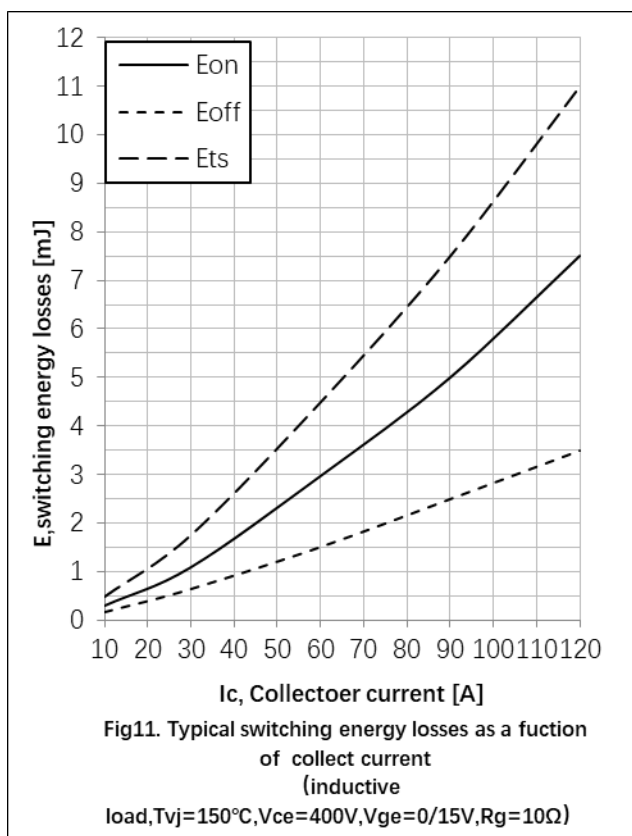
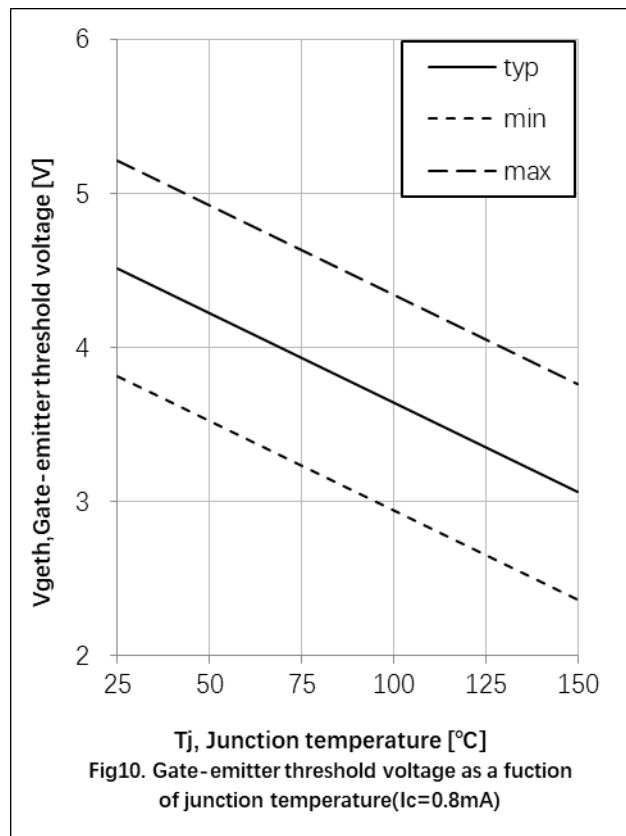
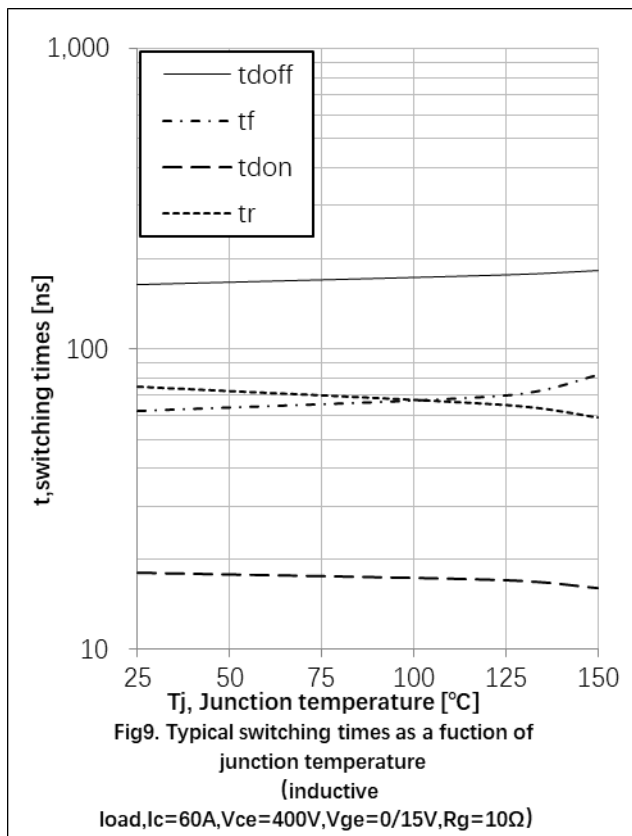

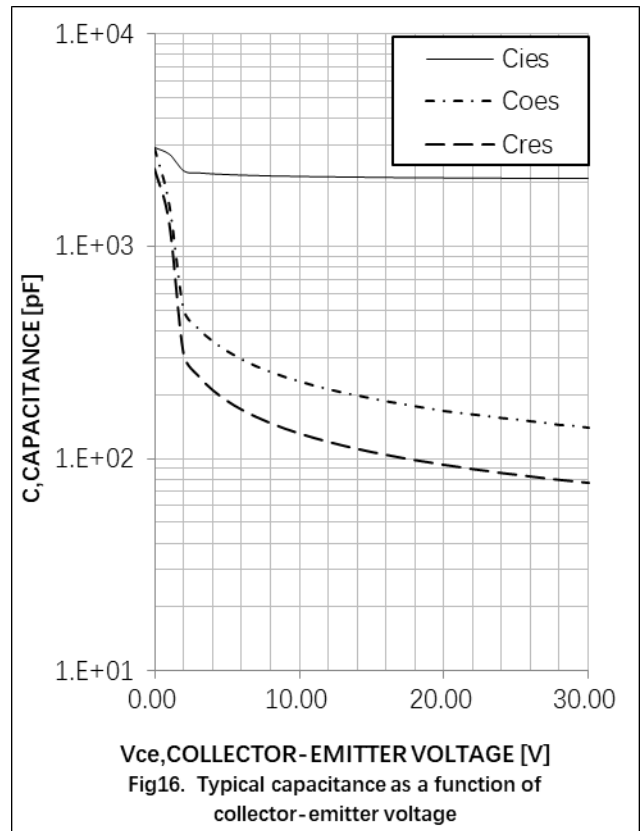
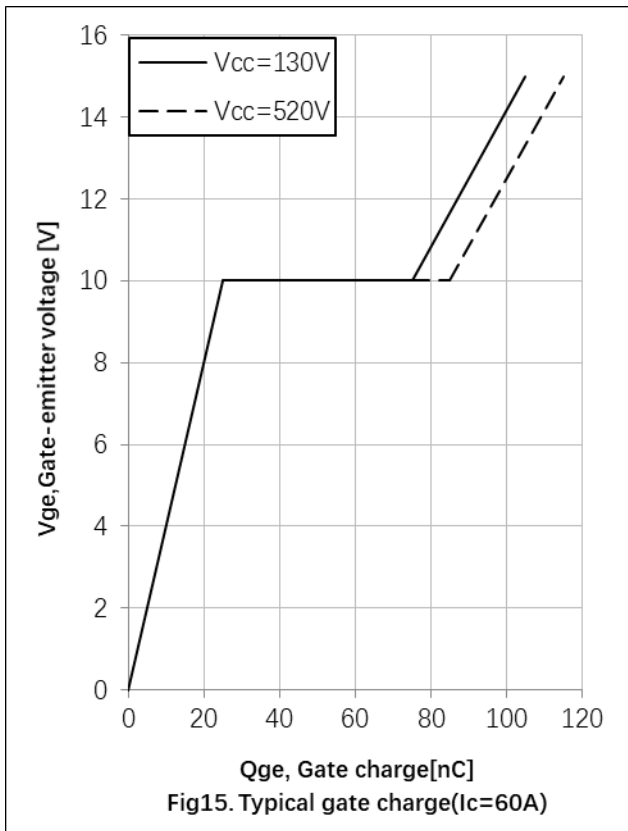
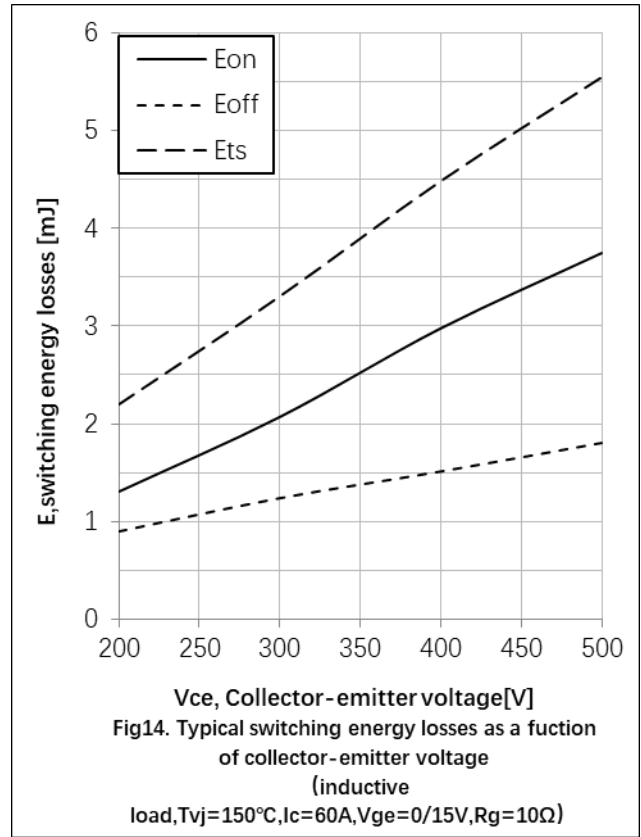
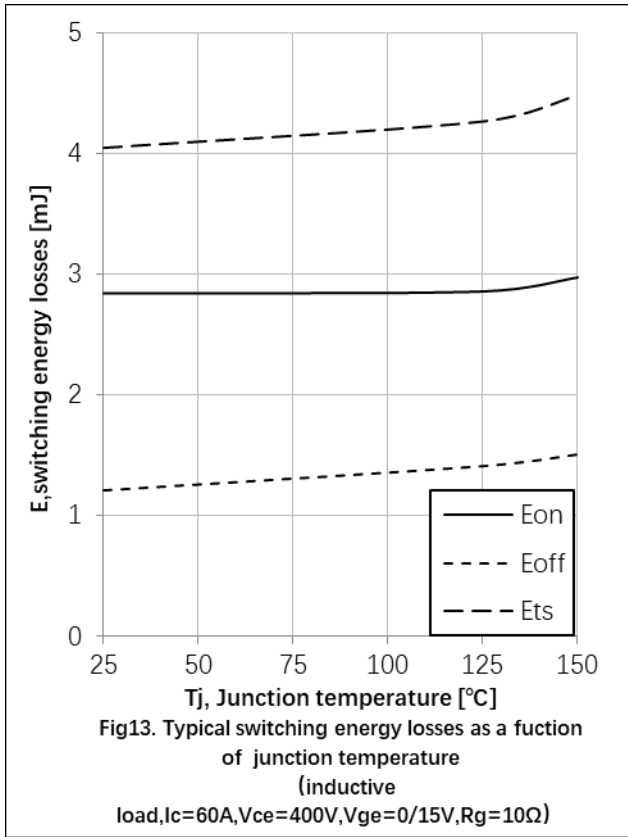



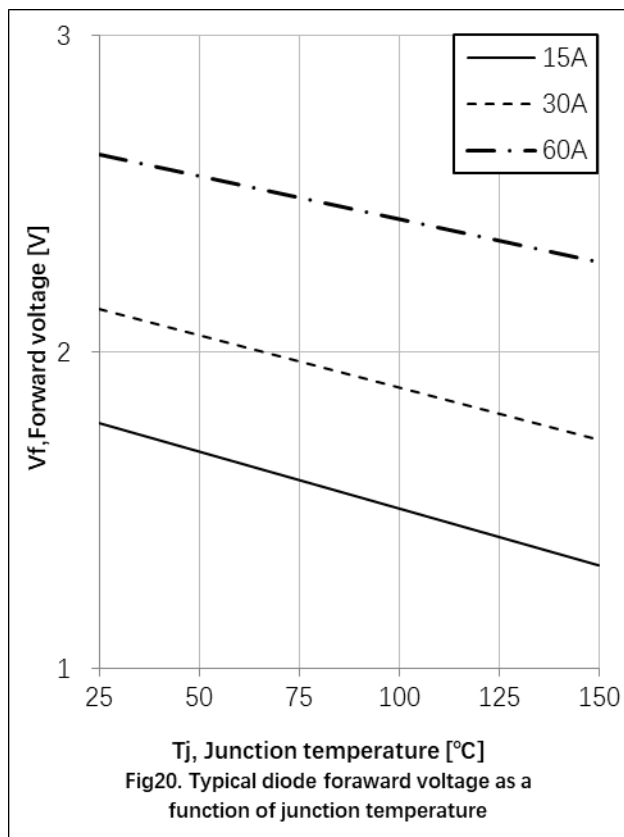
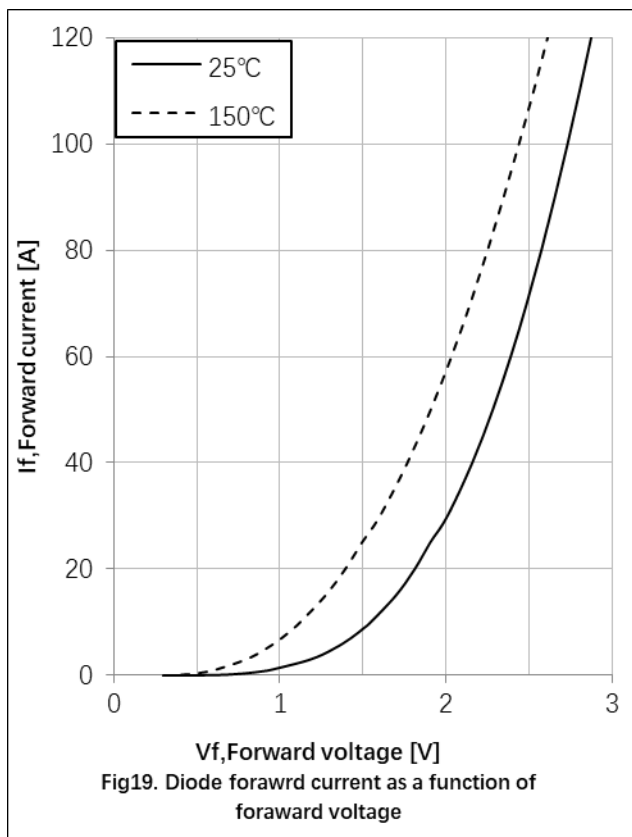
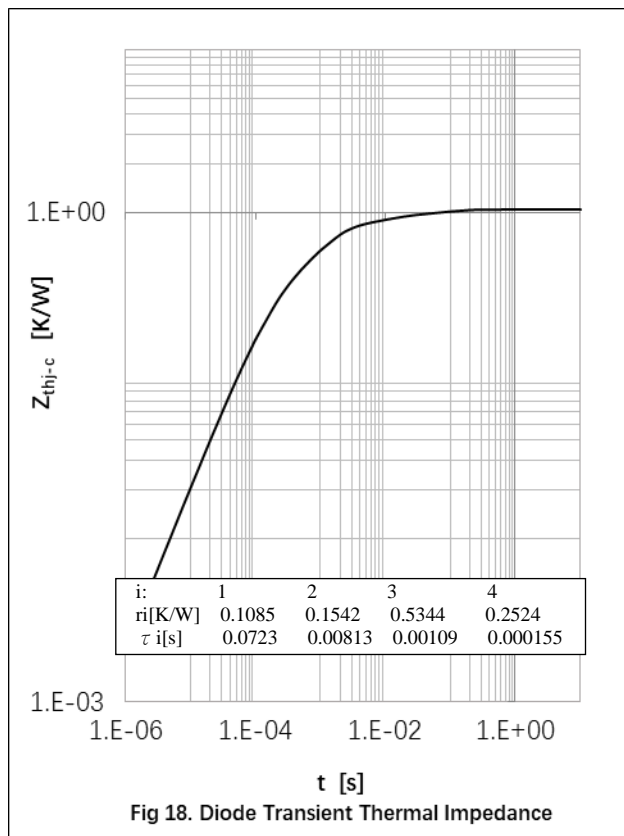
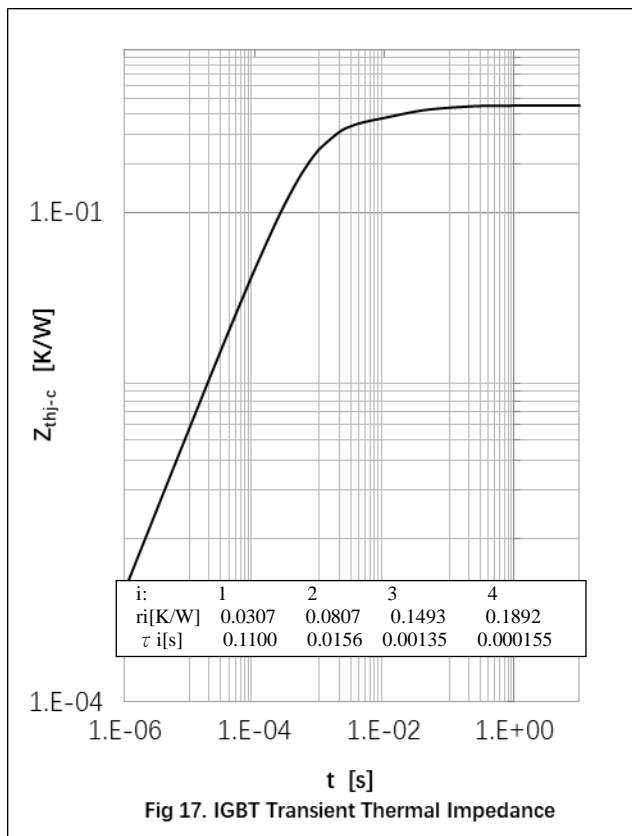

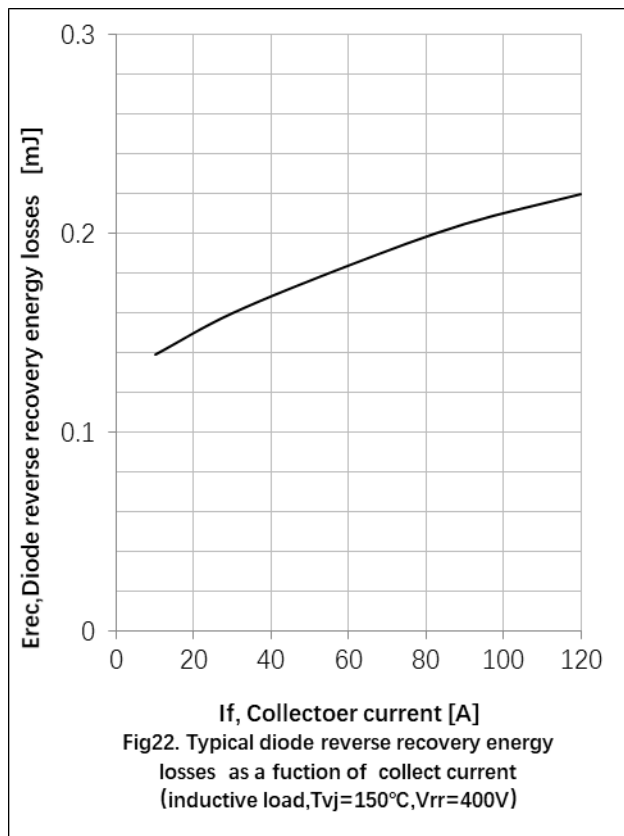
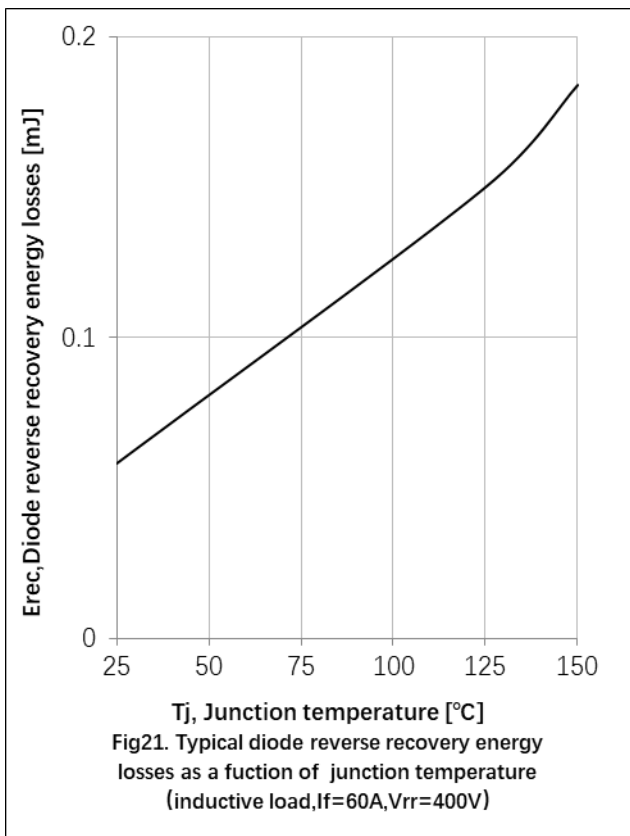

● **Circuit Diagram**

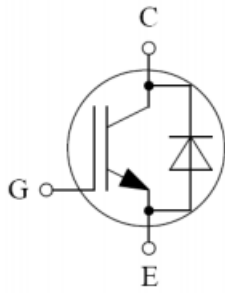

● **Package Outline Information**

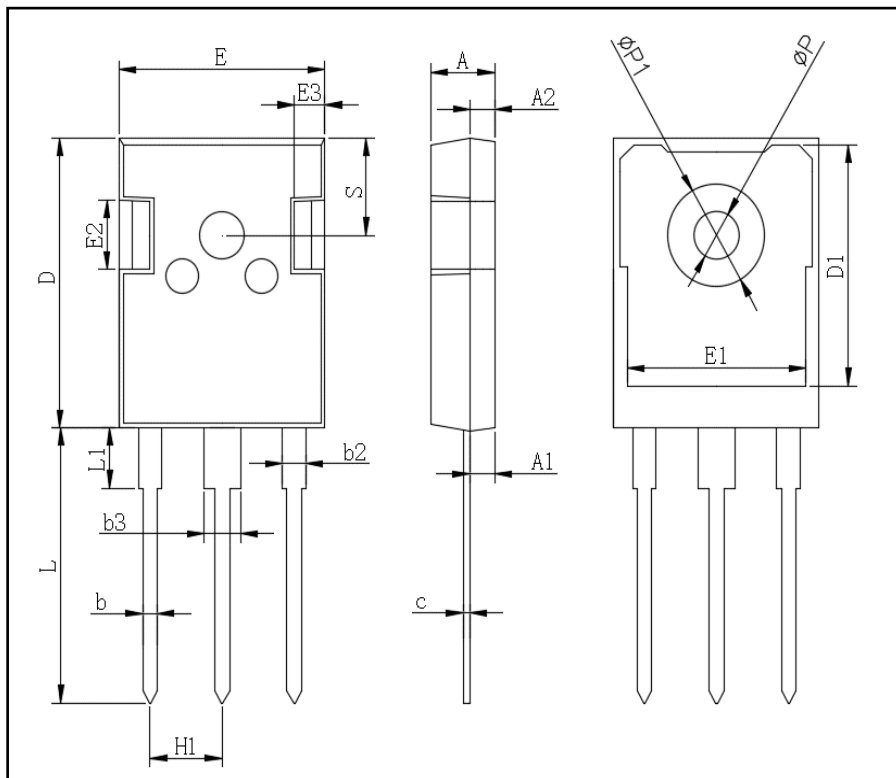

TO-247AB		
Dim	Min	Max
A	4.80	5.20
A1	2.21	2.61
A2	1.85	2.15
b	1.0	1.4
b2	1.91	2.21
C	0.5	0.7
D	20.70	21.30
D1	16.25	16.85
E	15.50	16.10
E1	13.0	13.6
E2	4.80	5.20
E3	2.30	2.70
L	19.62	20.22
L1	-	4.30
ΦP	3.40	3.80
ΦP1	-	7.30
S	6.15TYP	
H1	5.44TYP	
b3	2.80	3.20