

N-Channel Enhancement Mode Field Effect Transistor

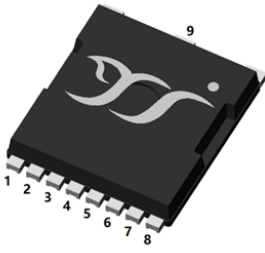

Top View

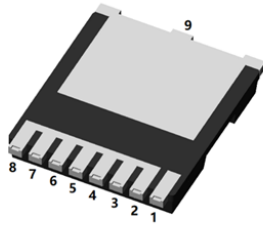

Bottom View

TOLL

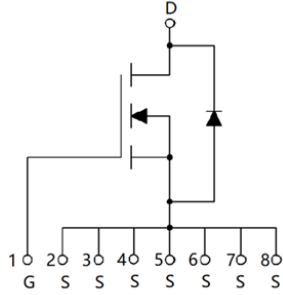

Product Summary

- V_{DS} 100V
- I_D 300A
- $R_{DS(ON)}$ (at $V_{GS}=10V$) $< 1.7m\Omega$
- $R_{DS(ON)}$ (at $V_{GS}=6V$) $< 2.5m\Omega$
- 100% EAS Tested
- 100% ∇V_{DS} Tested

General Description

- Split Gate Trench MOSFET technology
- Excellent package for heat dissipation
- High density cell design for low $R_{DS(ON)}$
- Epoxy Meets UL 94 V-0 Flammability Rating
- Halogen Free
- Moisture Sensitivity Level 1

Applications

- Load switch
- Battery management
- Solar

■ Absolute Maximum Ratings ($T_A=25^\circ C$ unless otherwise noted)

| Parameter | | Symbol | Limit | Unit |
|--|-------------------|----------------|----------|------------|
| Drain-source Voltage | | V_{DS} | 100 | V |
| Gate-source Voltage | | V_{GS} | ± 20 | V |
| Drain Current | $T_A=25^\circ C$ | I_D | 30 | A |
| | $T_A=100^\circ C$ | | 19 | |
| | $T_C=25^\circ C$ | | 300 | |
| | $T_C=100^\circ C$ | | 190 | |
| Pulsed Drain Current ^A | | I_{DM} | 1200 | A |
| Avalanche energy ^B | | EAS | 1440 | mJ |
| Total Power Dissipation ^C | $T_A=25^\circ C$ | P_D | 4 | W |
| | $T_A=100^\circ C$ | | 1.6 | |
| | $T_C=25^\circ C$ | | 250 | |
| | $T_C=100^\circ C$ | | 100 | |
| Junction and Storage Temperature Range | | T_J, T_{STG} | -55~+150 | $^\circ C$ |

■ Thermal resistance

| Parameter | | Symbol | Typ | Max | Units |
|---|--------------|-----------------|-----|-----|--------------|
| Thermal Resistance Junction-to-Ambient ^D | Steady-State | $R_{\theta JA}$ | 25 | 30 | $^\circ C/W$ |
| Thermal Resistance Junction-to-Case | Steady-State | $R_{\theta JC}$ | 0.4 | 0.5 | |

■ Ordering Information (Example)

| PREFERRED P/N | PACKING CODE | Marking | MINIMUM PACKAGE(pcs) | INNER BOX QUANTITY(pcs) | OUTER CARTON QUANTITY(pcs) | DELIVERY MODE |
|---------------|--------------|------------|----------------------|-------------------------|----------------------------|---------------|
| YJT300G10H | F1 | YJT300G10H | 2000 | 4000 | 20000 | 13" reel |



YJT300G10H

■ Electrical Characteristics ($T_J=25^\circ\text{C}$ unless otherwise noted)

| Parameter | Symbol | Conditions | Min | Typ | Max | Units |
|---------------------------------------|--------------|---|-----|-------|-----------|------------|
| Static Parameter | | | | | | |
| Drain-Source Breakdown Voltage | BV_{DSS} | $V_{GS}=0V, I_D=250\mu A$ | 100 | - | - | V |
| Zero Gate Voltage Drain Current | I_{DSS} | $V_{DS}=100V, V_{GS}=0V$ | - | - | 1 | μA |
| | | $V_{DS}=100V, V_{GS}=0V, T_J=150^\circ\text{C}$ | - | - | 100 | |
| Gate-Body Leakage Current | I_{GSS} | $V_{GS}=\pm 20V, V_{DS}=0V$ | - | - | ± 100 | nA |
| Gate Threshold Voltage | $V_{GS(th)}$ | $V_{DS}=V_{GS}, I_D=250\mu A$ | 2 | 2.8 | 4 | V |
| Static Drain-Source On-Resistance | $R_{DS(on)}$ | $V_{GS}=10V, I_D=150A$ | - | 1.35 | 1.7 | m Ω |
| | | $V_{GS}=10V, I_D=20A$ | - | 1.35 | 1.7 | |
| | | $V_{GS}=6V, I_D=20A$ | - | 1.75 | 2.5 | |
| Diode Forward Voltage | V_{SD} | $I_S=150A, V_{GS}=0V$ | - | 0.9 | 1.2 | V |
| Gate resistance | R_G | $f=1\text{MHz}$ | - | 1 | - | Ω |
| Maximum Body-Diode Continuous Current | I_S | | - | - | 300 | A |
| Dynamic Parameters | | | | | | |
| Input Capacitance | C_{iss} | $V_{DS}=50V, V_{GS}=0V, f=1\text{MHz}$ | - | 13600 | - | pF |
| Output Capacitance | C_{oss} | | - | 4000 | - | |
| Reverse Transfer Capacitance | C_{rss} | | - | 110 | - | |
| Switching Parameters | | | | | | |
| Total Gate Charge | Q_g | $V_{GS}=10V, V_{DS}=50V, I_D=150A$ | - | 257 | - | nC |
| Gate-Source Charge | Q_{gs} | | - | 89 | - | |
| Gate-Drain Charge | Q_{gd} | | - | 88 | - | |
| Reverse Recovery Charge | Q_{rr} | $I_F=150A, di/dt=100A/\mu s$ | - | 374 | - | nC |
| Reverse Recovery Time | t_{rr} | | - | 162 | - | ns |
| Turn-on Delay Time | $t_{D(on)}$ | $V_{GS}=10V, V_{DD}=50V, I_D=150A$ $R_{GEN}=2.2\Omega$ | - | 51 | - | ns |
| Turn-on Rise Time | t_r | | - | 158 | - | |
| Turn-off Delay Time | $t_{D(off)}$ | | - | 98 | - | |
| Turn-off fall Time | t_f | | - | 52 | - | |

A. Repetitive rating; pulse width limited by max. junction temperature.

B. $T_J=25^\circ\text{C}$, $V_{DD}=50V$, $V_G=10V$, $R_G=25\Omega$, $L=5\text{mH}$, $I_{AS}=24A$.

C. P_g is based on max. junction temperature, using junction-case thermal resistance.

D. The value of $R_{\theta JA}$ is measured with the device mounted on 1 in² FR-4 board with 2oz. Copper, in the still air environment with $T_A=25^\circ\text{C}$. The maximum allowed junction temperature of 150°C . The value in any given application depends on the user's specific board design.



YJT300G10H

Typical Electrical and Thermal Characteristics Diagrams

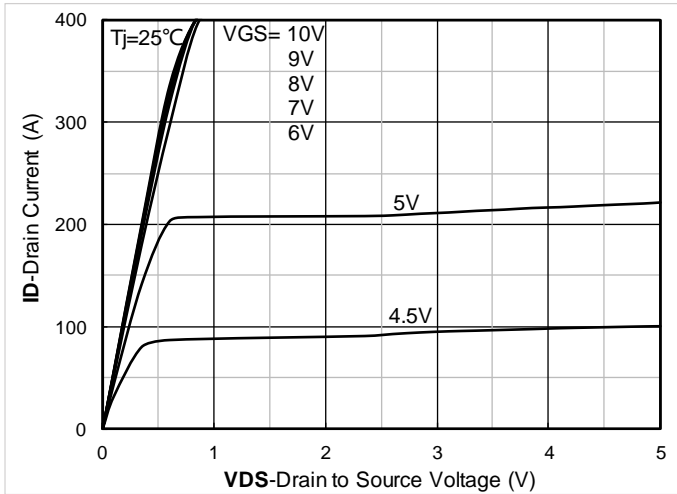

Figure 1. Output Characteristics

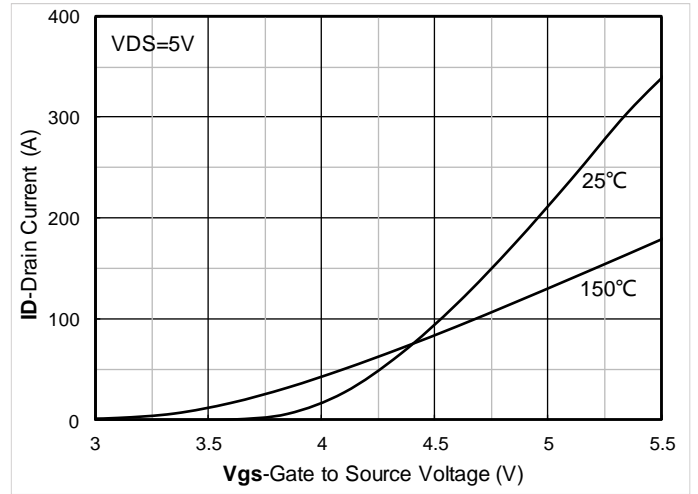

Figure 2. Transfer Characteristics

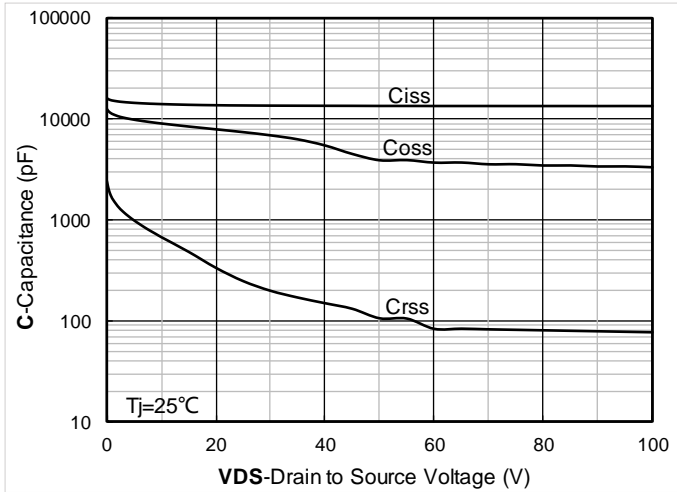

Figure 3. Capacitance Characteristics

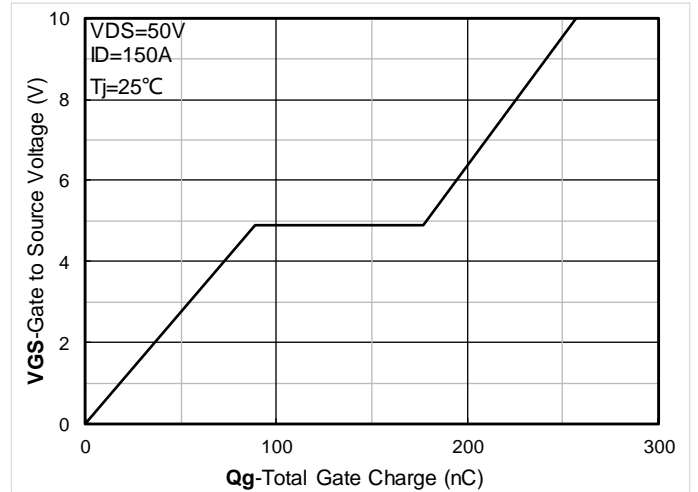

Figure 4. Gate Charge

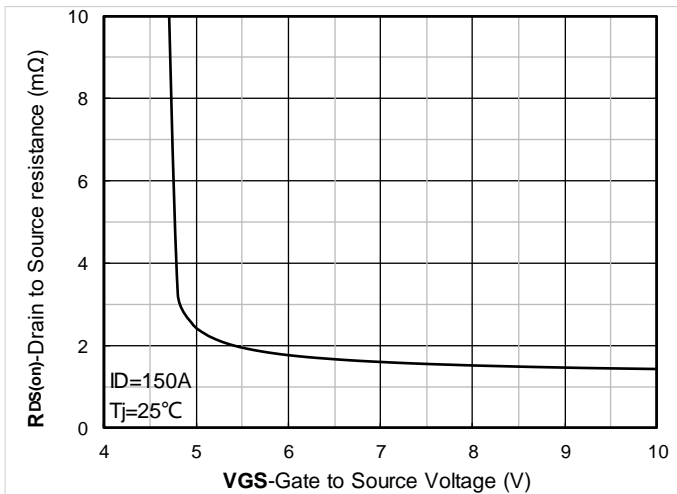

Figure 5. On-Resistance vs Gate to Source Voltage

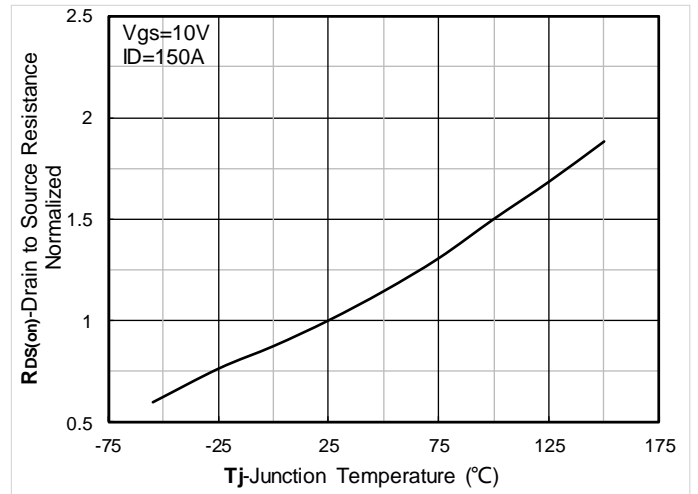

Figure 6. Normalized On-Resistance



YJT300G10H

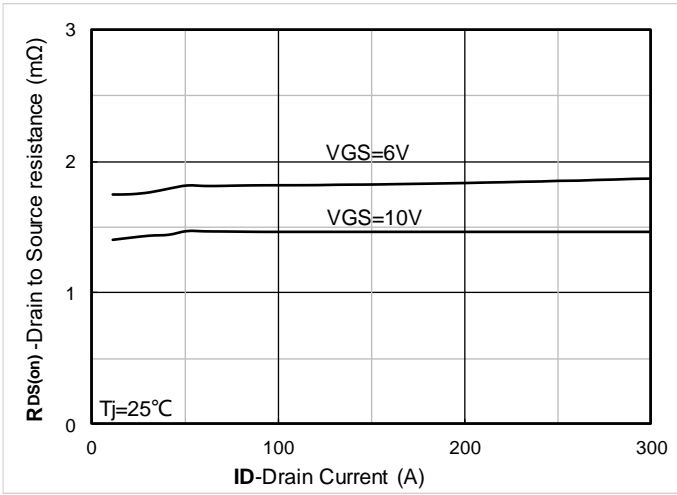

Figure 7. RDS(on) VS Drain Current

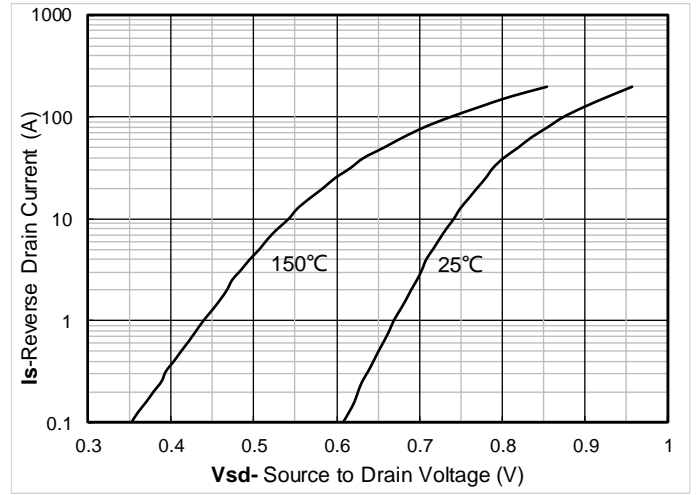

Figure 8. Forward characteristics of reverse diode

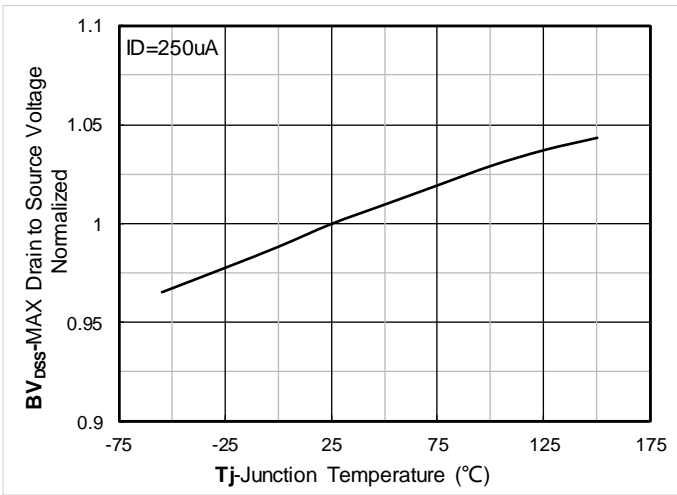

Figure 9. Normalized breakdown voltage

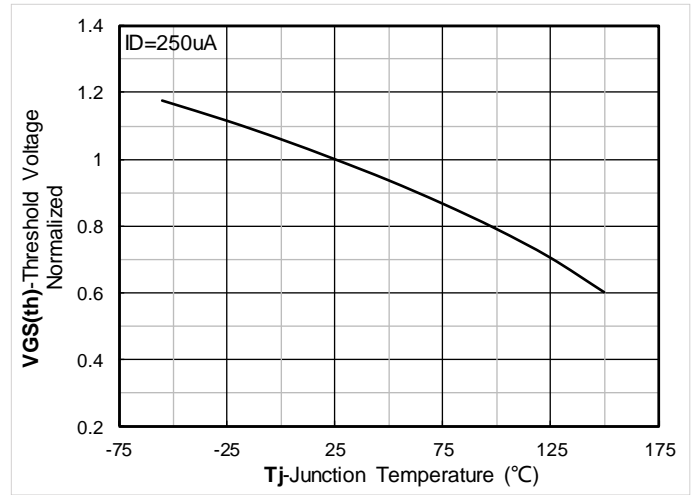

Figure 10. Normalized Threshold voltage

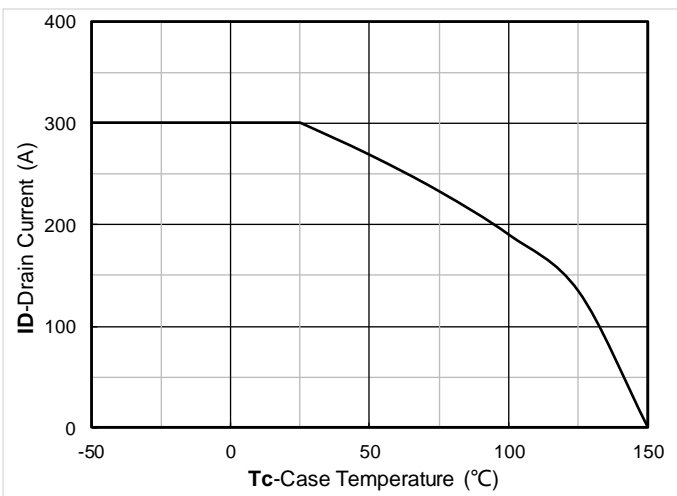

Figure 11. Current dissipation

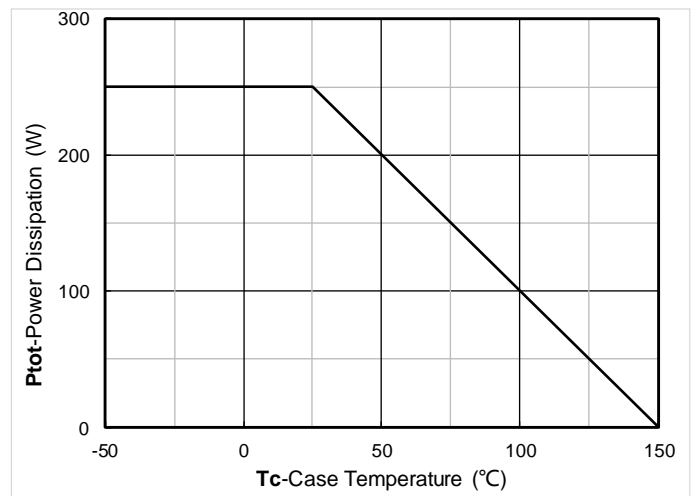

Figure 12. Power dissipation

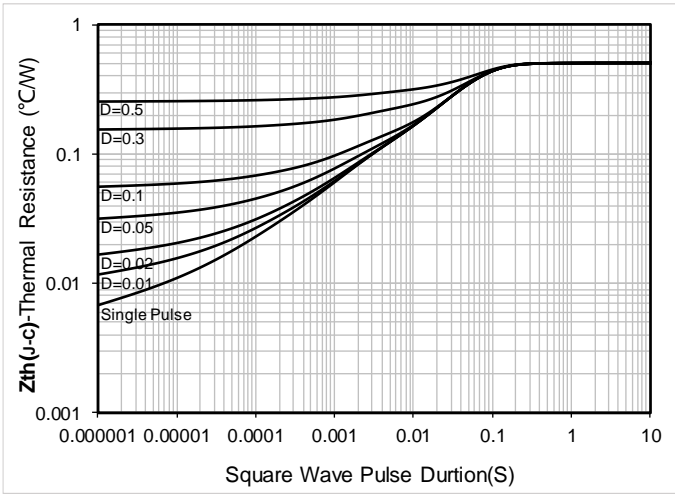

Figure 13. Maximum Transient Thermal Impedance

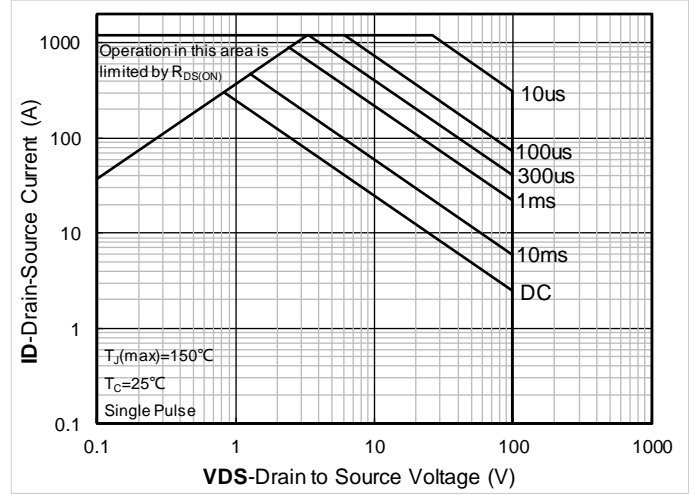

Figure 14. Safe Operation Area

■ Test Circuits & Waveforms

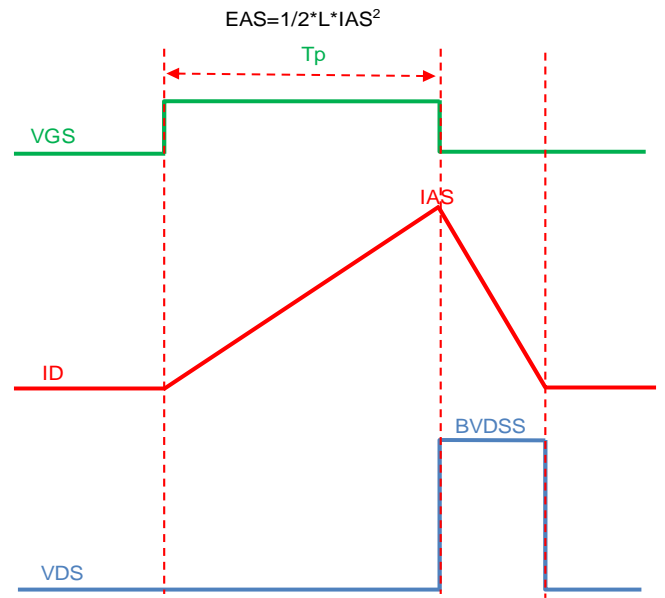
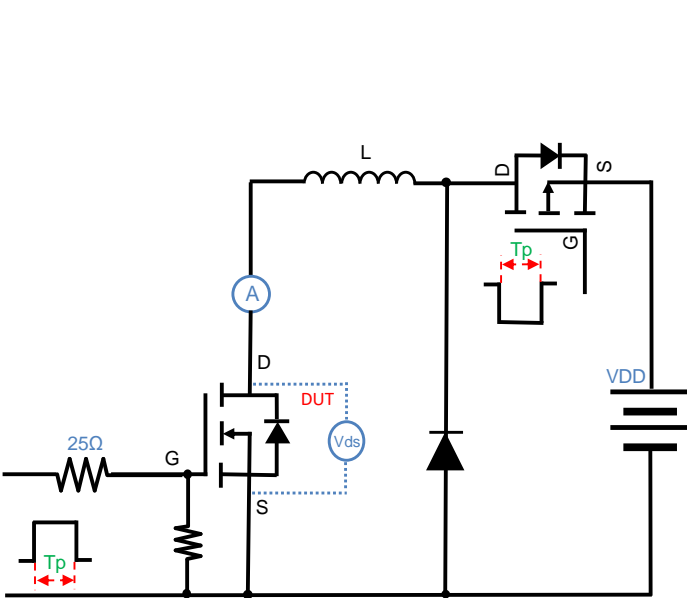

Figure A. Unclamped Inductive Switching (UIS) Test Circuit & Waveform



Figure B. Gate Charge Test Circuit & Waveform



Figure C. Resistive Switching Test Circuit & Waveform

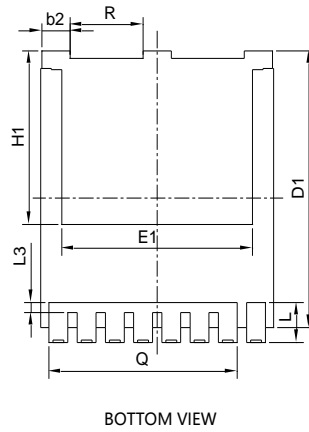
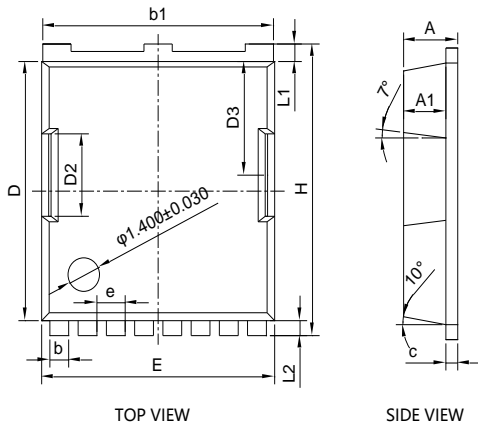

Figure D. Diode Recovery Test Circuit & Waveform



YJT300G10H

■ TOLL Package information



| SYMBOL | MILLIMETER | | |
|--------|------------|-------|-------|
| | MIN | NOM | MAX |
| A | 2.2 | 2.3 | 2.4 |
| A1 | 1.7 | 1.8 | 1.9 |
| b | 0.7 | 0.8 | 0.9 |
| b1 | 9.7 | 9.8 | 9.9 |
| b2 | 1.1 | 1.2 | 1.3 |
| c | 0.4 | 0.5 | 0.6 |
| D | 10.28 | 10.38 | 10.48 |
| D1 | 10.98 | 11.08 | 11.18 |
| D2 | 3.2 | 3.3 | 3.4 |
| D3 | 4.45 | 4.55 | 4.65 |
| E | 9.8 | 9.9 | 10 |
| E1 | 8 | 8.1 | 8.2 |
| e | 1.2 BSC | | |
| H | 11.58 | 11.68 | 11.78 |
| H1 | 6.95 BSC | | |
| i | 0.1 REF | | |
| j | 0.46 REF | | |
| L | 1.5 | 1.6 | 1.7 |
| L1 | 0.6 | 0.7 | 0.8 |
| L2 | 0.5 | 0.6 | 0.7 |
| L3 | 0.3 | 0.4 | 0.5 |
| Q | 8 REF | | |
| R | 3.0 | 3.1 | 3.2 |

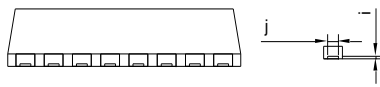

- Note:
1. Controlling dimension: in millimeters.
 2. General tolerance: $\pm 0.03\text{mm}$.
 3. The pad layout is for reference purposes only.

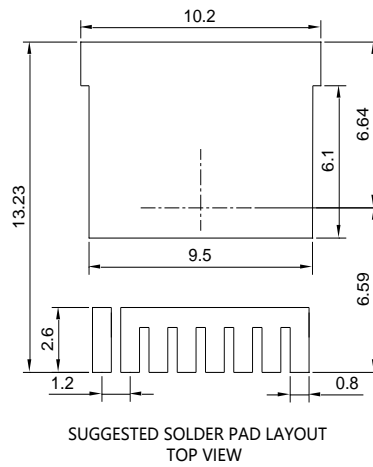

UNIT: mm



YJT300G10H

Disclaimer

The information presented in this document is for reference only. Yangzhou Yangjie Electronic Technology Co., Ltd. reserves the right to make changes without notice for the specification of the products displayed herein to improve reliability, function or design or otherwise.

The product listed herein is designed to be used with ordinary electronic equipment or devices, and not designed to be used with equipment or devices which require high level of reliability and the malfunction of which would directly endanger human life (such as medical instruments, transportation equipment, aerospace machinery, nuclear-reactor controllers, fuel controllers and other safety devices), Yangjie or anyone on its behalf, assumes no responsibility or liability for any damages resulting from such improper use of sale.

This publication supersedes & replaces all information previously supplied. For additional information, please visit our website <http://www.21yangjie.com> , or consult your nearest Yangjie's sales office for further assistance.