

Small Signal Schottky Diode

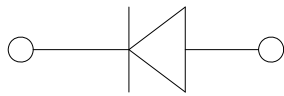
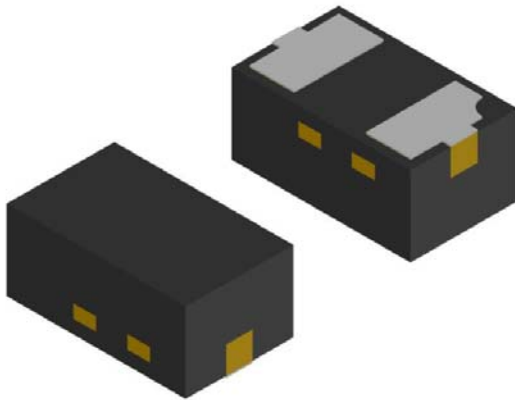

Features

- Low Forward Voltage
- High Conductance
- Lead Free Finish/RoHS Compliant
- Small package saves board space
- Moisture Sensitivity Level 3

Mechanical Data

- **Package:** DFN1006-2L
- **Terminals:** Tin plated leads, solderable per J-STD-002 and JESD22-B102
- **Polarity:** Cathode line denotes the cathode end
- **Marking:** D1

■Maximum Ratings (T_a=25°C Unless otherwise specified)

Item	Symbol	Unit	Conditions	Limit Max
Power Dissipation	P _D	mW		100
Storage Temperature	T _{STG}	°C		-40 to +125
Junction Temperature	T _J	°C		125
DC Reverse Voltage	V _R	V		40
Average Rectified Forward Current	I _{FAV}	mA		200
Peak Forward Surge Current	I _{FSM}	A	8.3ms single half sine-wave	1.0

■Electrical Characteristics (T_a=25°C Unless otherwise specified)

Item	Symbol	Unit	Conditions	Min	Max
Breakdown Voltage	V _R	V	I _R =100uA	40	-
Forward Voltage	V _F	V	I _F =10mA	-	0.39
			I _F =100mA	-	0.55
Reverse Leakage Current	I _R	uA	V _R =10V	-	1
			V _R =40V	-	10

■Ordering Information (Example)

PREFERRED P/N	UNIT WEIGHT(mg)	MINIMUM PACKAGE(pcs)	INNER BOX QUANTITY(pcs)	OUTER CARTON QUANTITY(pcs)	DELIVERY MODE
RB520S-40L2	Approximate 0.9	10K	100K	400K	Tape & Reel



■ Characteristics (Typical)

Forward Characteristics

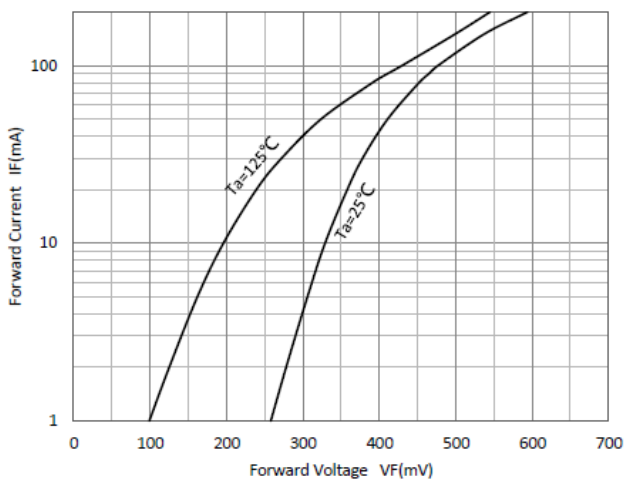

IR-VR

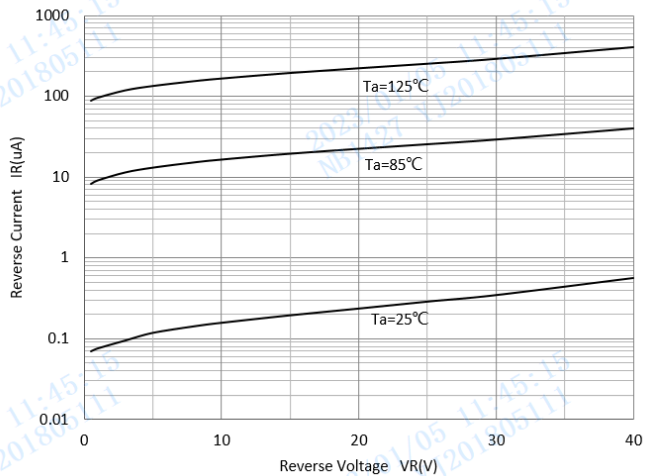

Capacitance Characteristics

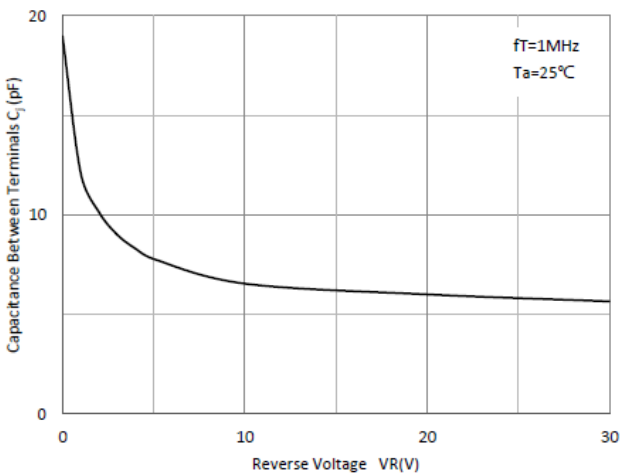

■ Outline Dimensions

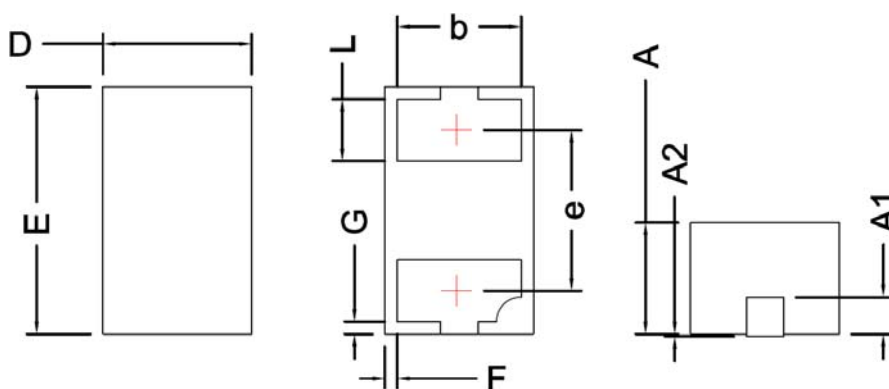

SYMBOL	MILLIMETER		
	MIN	NOM	MAX
D	0.50	0.60	0.70
E	0.90	1.00	1.10
A	0.35	0.45	0.55
A1	0.15 BSC		
A2			0.10
F	0.005		
G	0.005		
L	0.15	0.25	0.35
b	0.41	0.50	0.59
e	0.65 BSC		

■ Soldering Footprint

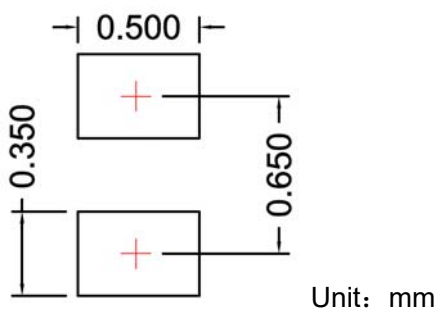



RB520S-40L2

Disclaimer

The information presented in this document is for reference only. Yangzhou Yangjie Electronic Technology Co., Ltd. reserves the right to make changes without notice for the specification of the products displayed herein to improve reliability, function or design or otherwise.

The product listed herein is designed to be used with ordinary electronic equipment or devices, and not designed to be used with equipment or devices which require high level of reliability and the malfunction of which would directly endanger human life (such as medical instruments, transportation equipment, aerospace machinery, nuclear-reactor controllers, fuel controllers and other safety devices), Yangjie or anyone on its behalf, assumes no responsibility or liability for any damages resulting from such improper use of sale.

This publication supersedes & replaces all information previously supplied. For additional information, please visit our website [http:// www.21yangjie.com](http://www.21yangjie.com) , or consult your nearest Yangjie's sales office for further assistance.